

SPECIFICATION FOR APPROVAL

Customer Name :

Customer Item :

Part No. : PI-S188HQ-CS14-HGT

Product Description :

Draw Date :

1.Accessory: Samples Samples Data

2.Customer's Proposal : Agree Disagree

Reason :



Rev.	Draw by :	Checked by :	Approved by :
1.2.2	Steven Chen	Gray Huang	Caren
Customer Approve			

Features

1.8mmx0.8mm SMD LED, 0.55mm thickness

Welding Plate 0.1mm*2

Low power consumption

Wide view angle

Package: 4000pcs/reel

RoHS Compliant



Package outlines/ Recommend Pad Layout

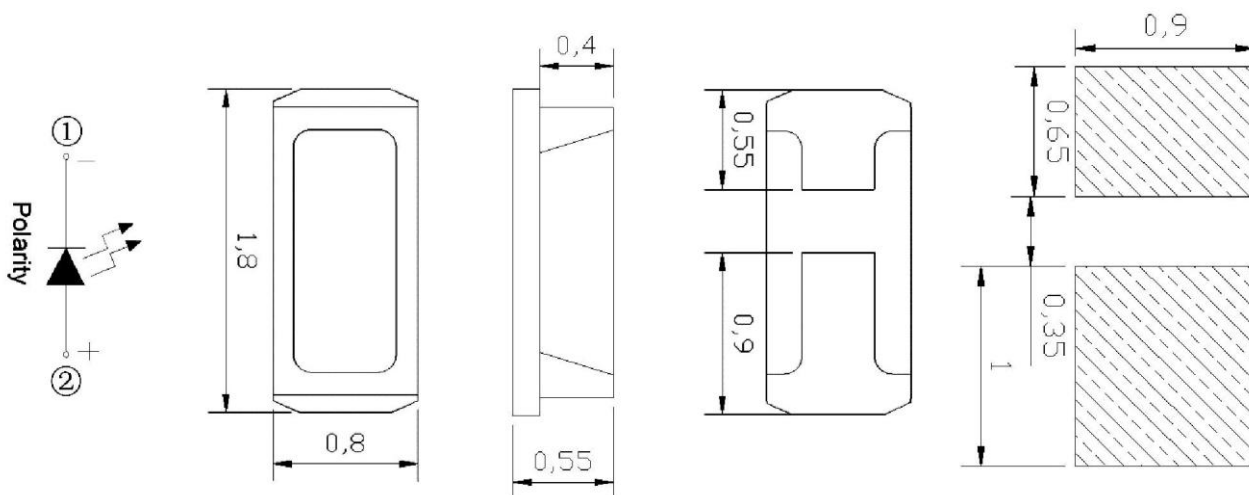

Part No.	Emitted color	Dice	Lens color
PI-S188HQ-CS14-HGT	IR	AlGaInP	Water transparent

Notes:

1. All dimensions are in millimeters (inches);
2. Tolerances are $\pm 0.1\text{mm}$ (0.004inch) unless otherwise noted.

Absolute Maximum Ratings (Ta=25°C)

Parameter	Symbol	Value	Unit
Forward current	If	20	mA
Reverse voltage	Vr	5	V
Operating temperature	Top	-40 ~+85	°C
ESD(Human-body mode)	--	2	KV
Storage temperature	Tstg	-40 ~+85	°C
Peak pulsing current (1/8 duty f=1kHz)	Ifp	200	mA

Electro-Optical Characteristics (Ta=25°C)

Parameter	Test Condition	Symbol	Value			Unit
			Min	Typ	Max	
Wavelength at peak emission	If=20mA	λ_p	920	940	960	nm
Forward voltage	If=20mA	Vf	1.2	1.6	1.8	V
	If=100mA	Vf	--	--	2.0	V
Luminous intensity	If=20mA	Iv	2.4	4	--	mw/sr
	If=20mA	Iv	--	12	--	mw
Viewing angle at 50% Iv	If=20mA	2 θ 1/2	--	120	--	Deg
Reverse current	Vr=5V	Ir	--	--	10	μ A

Radiation Characteristics

IF=50mA, Ta=25°C

Forward Current Vs. Forward Voltage

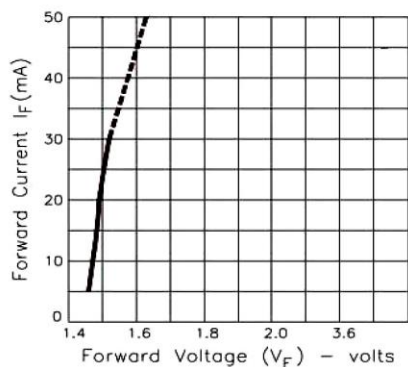

Luminous Intensity Vs. Forward Current

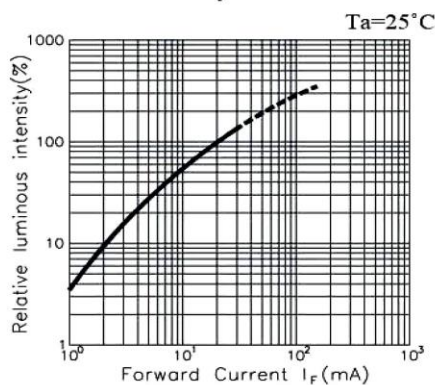

Forward Current Derating Curve

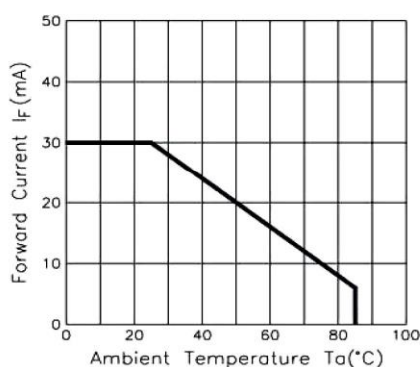

Radiation Diagram

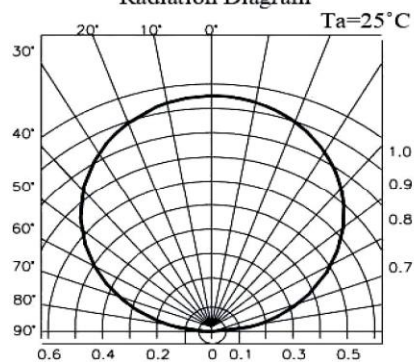

Spectrum Distribution

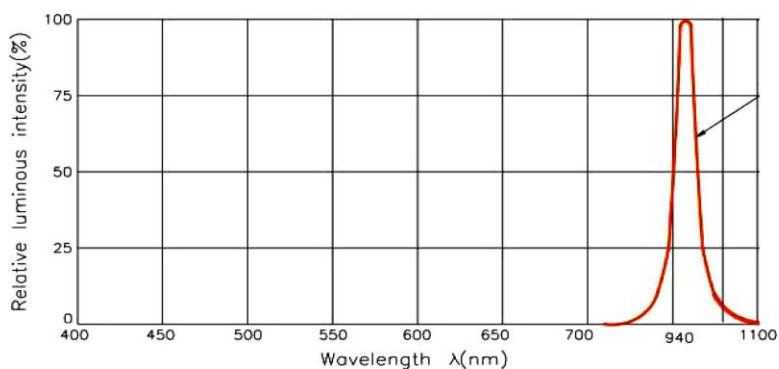

Reflow Profile

■ Reflow Temp/Time

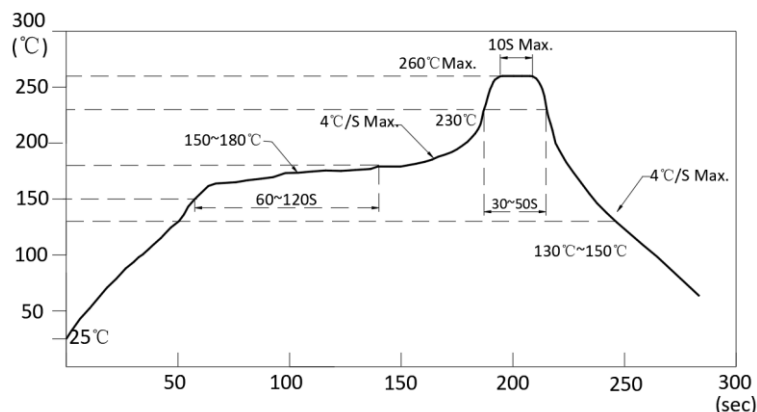

Notes:

1. We recommend the reflow temperature 245°C ($\pm 5^\circ\text{C}$).
2. The maximum soldering temperature should be limited to 260°C.
3. Don't cause stress to the epoxy resin while it is exposed to high temperature.
4. Number of reflow process shall be 2 times or less.

■ Soldering iron

Basic spec is $\frac{6}{\lambda}$ 5sec when 320°C ($\pm 20^\circ\text{C}$). If temperature is higher, time should be shorter (+10°C \rightarrow -1sec).

Power dissipation of iron should be smaller than 20W, and temperatures should be controllable. Surface temperature of the device should be under 350°C.

■ Rework

1. Customer must finish rework within 5 sec under 340°C.
2. The head of iron cannot touch copper foil
3. Twin-head type is preferred.

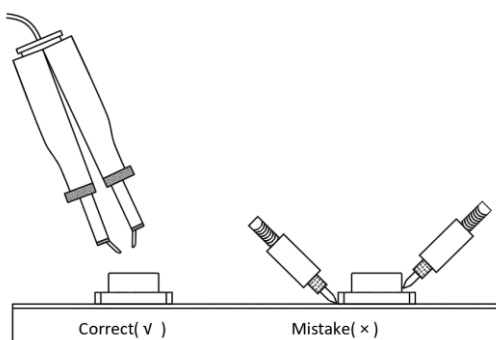

- Avoid rubbing or scraping the resin by any object, during high temperature, for example reflow solder etc.

Handling precautions

1. Drive Method

A LED is a current-operated device. In order to ensure intensity uniformity on multiple LEDs connected in parallel in an application, it is recommended that a current limiting resistor be incorporated in the drive circuit, in series with each LED as shown in Circuit below.

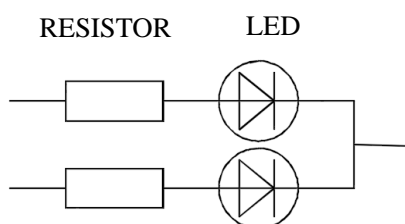

2. Storage

2.1 Do not open moisture proof bag before the products are ready to use.

2.2 Before opening the package: The LEDs should be kept at 30°C or less and 60% RH or less.

2.3 After the package is opened, the products should be used within a week or they should be keeping to store at ≤ 20 R.H. with zip-lock sealed.

3. Baking

It is recommended to baking before soldering when the pack is unsealed after 72hrs. The Conditions are as followings:

3.1 $60 \pm 3^{\circ}\text{C}$ x (12~24hrs) and $< 5\%$ RH, taped reel type

3.2 $100 \pm 3^{\circ}\text{C}$ x (45min~1hr), bulk type

3.3 $130 \pm 3^{\circ}\text{C}$ x (15~30min), bulk type

Test Items and Results of Reliability

Test Item	Test Conditions	Standard Test Method	Note	Number Of Test
Reflow Soldering	Ta=260±5°C, Time=10±2S	JB/T 10845-2008	3times	0/22
Salt Atmosphere	Ta=35±3°C, PH=6.5 ~ 7.2	GB/T 2423.17-2008	24hrs	0/22
Temperature Cycling	-40±5°C 30±1min ↑→(25°C/5±1min)↓ 100±5°C 30±1min	GB/T 2423.22-2012	100cycles	0/22
Thermal Shock	Ta=-40±5°C ~ 100±5°C, 15±1min dwell	GB/T 2423.22-2012	100cycles	0/22
High Humidity High Temp. Cycling	Ta=30±5°C ~ 65±5°C, 90±5%RH, 24hrs/1cycle	GB/T 2423.4-2008	10cycles	0/22
High Humidity High Temp. Storage Life	Ta=85±5°C, ψ(%)=85±5%RH	GB/T 2423.3-2006	1000hrs	0/22
High Temperature Storage Life	Ta=100±5°C, non-operating	GB/T 2423.2-2008	1000hrs	0/22
Low Temperature Storage Life	Ta=-40±5°C, non-operating	GB/T 2423.1-2008	1000hrs	0/22
Life Test	Ta=26±5°C, @20mA, ψ(%)=25%RH ~ 55%RH	--	1000hrs	0/22
High Humidity High Temp. Operating Life	Ta=85±5°C, @20mA, ψ(%)=85%RH	GB/T 2423.3-2006	500hrs	0/22
Low Temperature Operating Life	Ta=-20±5°C, @20mA	GB/T 2423.1-2008	1000hrs	0/22